

Article number: 209076811

Description: E+G Ball point screw
GN 605-M12-40-VNR

Measures

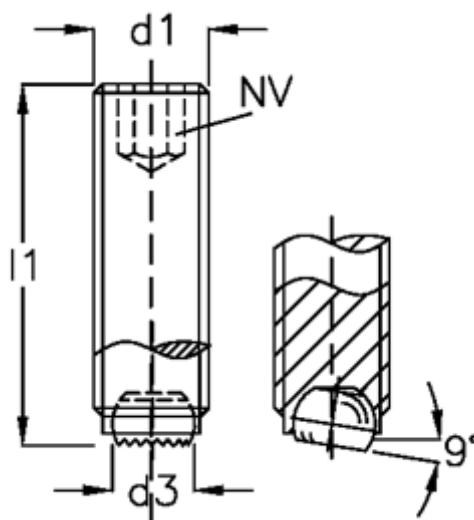

d1	= M12
d2	= 8.0
d3	= 7.2
Internal hexagon	= 6
l1	= 40